

GENUINE PATZ CHAIN & REPLACEMENT CONTACT POINTS



PATZ, THE ORIGINAL PATENTED HOOK & EYE CHAIN!

The Patz Model 400 Barn Cleaner with patented Hook-&-Eye chain is the premier product to put Pound, WI on the map, and propel a family name brand world-wide! Years of design improvements and manufacturing innovations are the trademark of an industry leader, and our guarantee this product line is the best it has ever been! Whether called a *Gutter Cleaner*, *Barn Sweep*, or *Stable Cleaner*, only one name stands out—PATZ.

PATZ LINK & FLITES



RETHINK THE LINK!

- ▶ Famous for its unique **Hook-&Eye** design, the Patz link is engineered for uniform pitch length and precision contours on all load bearing surfaces to ensure smooth operation and longevity.
- ▶ Every Patz 400 link begins with superior raw materials—proprietary alloy steels for a stronger, tougher, and more wear resistant chain.
- ▶ Not a casting, each link is produced in a state-of-the-art, closed-die hammer forged process in which the metal is compressed, condensing the grain structure to make a stronger link, with longer service life.
- ▶ Heat treated through this advanced true forging process maximizes impact tolerance, fracture strength, and fatigue resistance.
- ▶ Patz 12-Point inspection completes the manufacturing processes and quality assurance procedures to ensure the ultimate in product performance.
- ▶ Finally, Patz premium powder-coat seals the superior surface finish of improved forging to reduce break-in wear.

MULTIPLE CUSTOM FLITE OPTIONS FOR EVERY APPLICATION

- ▶ Flites are made to order in widths of 15-20 inches, sized in increments of ½ inch. Choose from right-hand (counterclockwise) or left-hand (clockwise) based upon system loading.

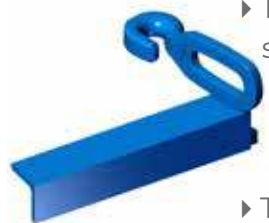

- ▶ The Patz **Model 447 (Low) Flite** is made from 2-inch x 2-inch (51 mm) structural steel angle.

- ▶ Optimal for fibrous material and minimal inclines.



- ▶ The Patz **Model 467 (High) Flite** is 4-inches-high at the end of an 18-inch wide (457 mm) flite. This added height helps prevent material rollback and carries more material. The leading edge of the 467 flite extends under the link, providing wall-to-wall conveying.

- ▶ Recommended for finer material with high moisture content, and steeper incline conveying.

- ▶ With the patented Hook-&Eye Patz link, flite spacing is easily adjusted to 12, 18, or 24 inch spacing (305, 457, or 610 mm) to optimize conveying capacity. Optional premium quality powder-coating of Links and Flites slows corrosion and minimizes break-in wear.



WHY BUY GENUINE PATZ FLITES?

- ▶ Flites consist of three components: the **link**, **paddle**, and **wear shoe**.
- ▶ Patz specialized welding techniques increase strength and provide reliability of the **link-paddle-shoe** connection.
 - ▶ Paddles are cut and welded to the link at an exact angle to prevent binding in the gutter or trough while allowing close tolerance for clean material flow.
 - ▶ As material is discharged, the flite angle pushes material to the outside, away from the center beam, chain linkage, and drive sprocket.
- ▶ Patz **one-of-a-kind** wear shoe at 2-inch-wide x 3 ¼-inch-long and ½-inch thick provides maximum strength and durability and is key to longer service life.
 - ▶ The expanded wear shoe delivers greater load support on the channel floor, requiring less pressure per square inch—reducing concrete gutter grooving and steel trough floor wear, while providing optimal flite stability in corner movement.

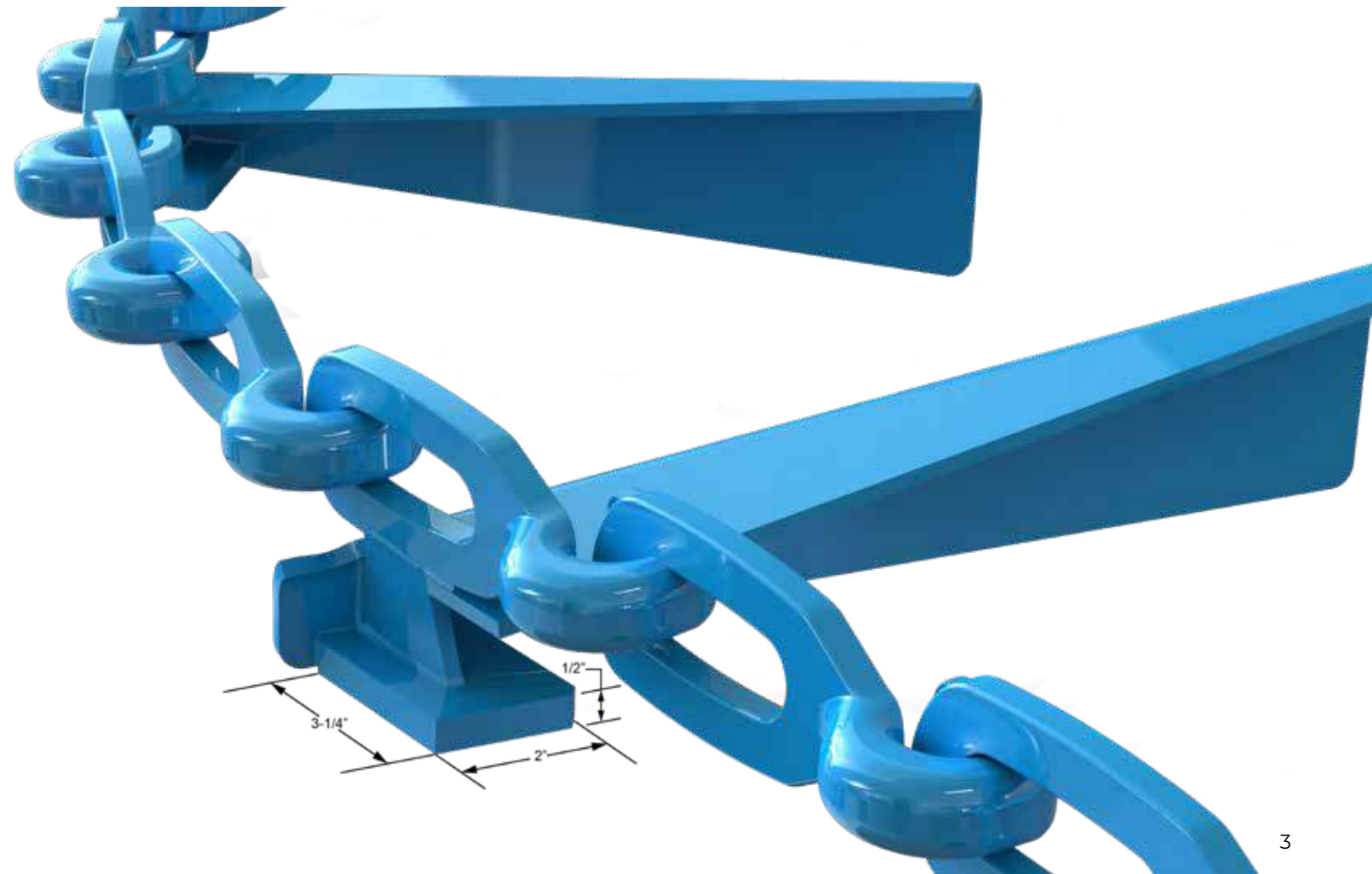

Genuine Patz Chain & Replacement Contact Points

CONTACT POINTS LAYOUT

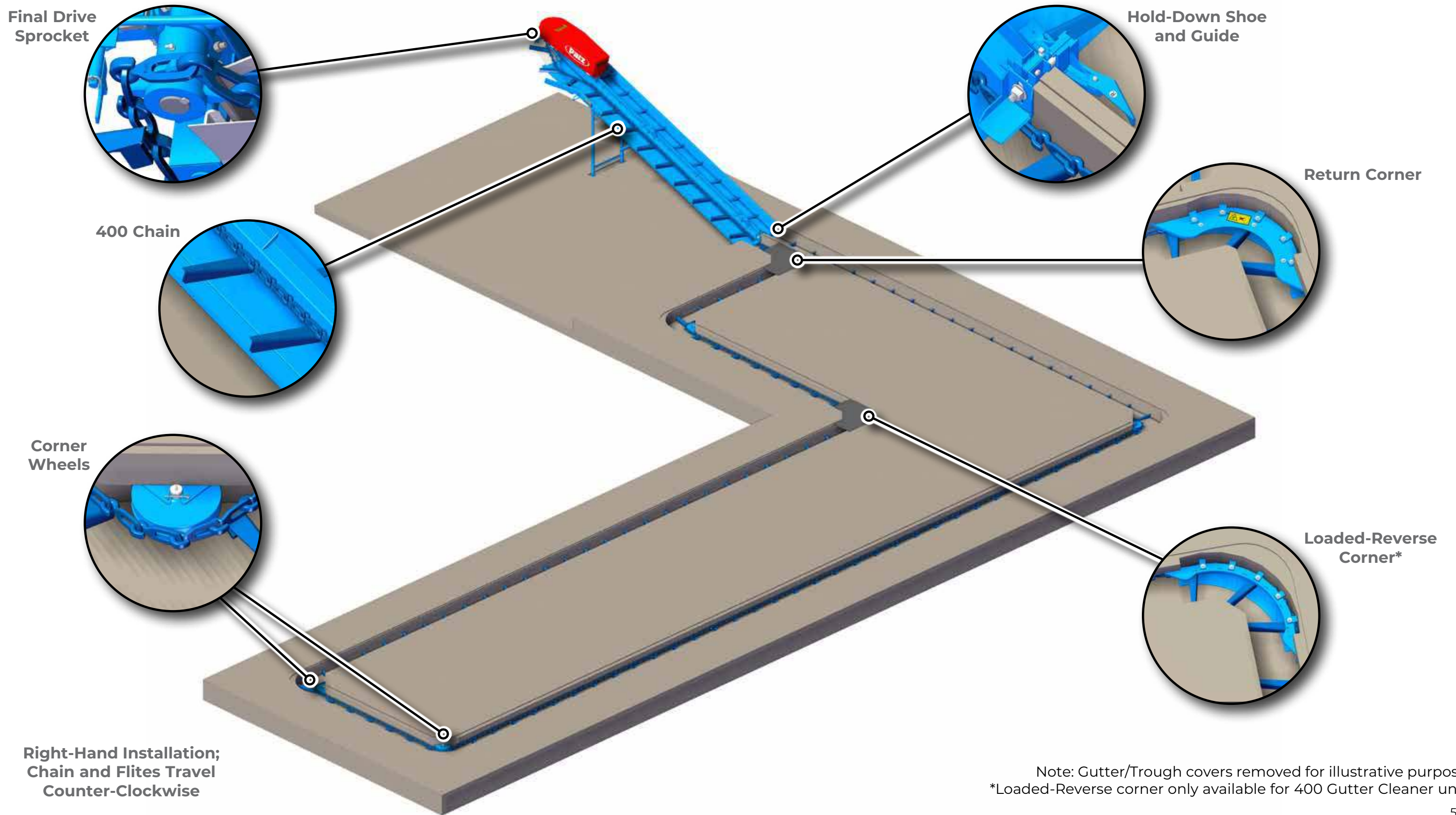

Genuine Patz Chain & Replacement Contact Points

CONTACT POINTS

SAVE YOUR CHAIN WITH PATZ CONTACT POINTS

► Guarantee your Patz 400 Replacement Chain Investment and 15-Year Chain Warranty when you add genuine Patz contact points. Be sure to replace the Contact Points (**Drive Sprockets, Hold-Down Shoes, Corner Wheels, and Return Corner Guides**) to assure a safe, smooth, and efficient operation.

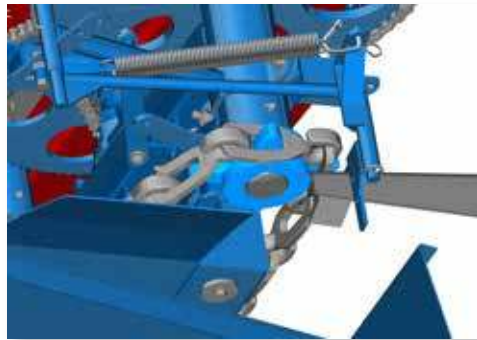

► **Drive Sprockets:** Drive new chain with Patz laser cut sprockets precision engineered with a purpose.

- Manufactured from a special alloy steel for increased durability and longer life, all drive sprockets are fiber-optic laser cut to the exact pitch length of the Patz 400 chain.
- Precision matched chain and sprocket pitch length ensures your system runs much quieter and smoother, for years of service.

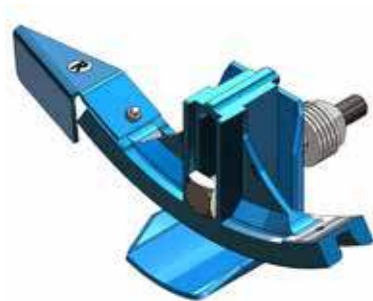

► **Hold Down Shoes:** Maintaining flite leading edge contact full to the floor is critical when transitioning from a horizontal to inclined channel. Worn and improper shoes allow flites to float above material.

- Engineered to precisely fit the Patz link, this precision ductile iron casting is through-hardened for durability, with uniform thickness throughout the entire shoe to prolong chain life.
- Heat-treatment results in hardness throughout the entire casting, not just the outside edge.

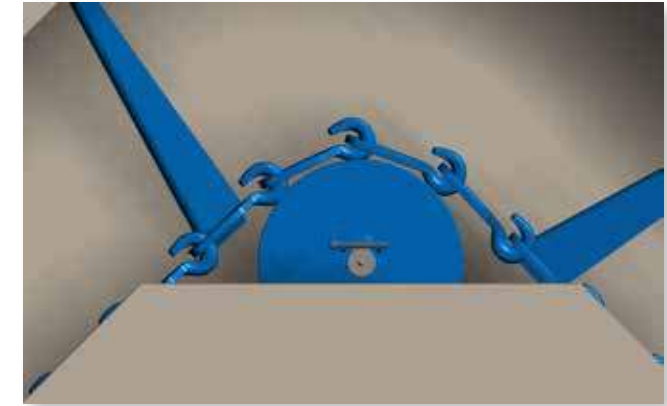
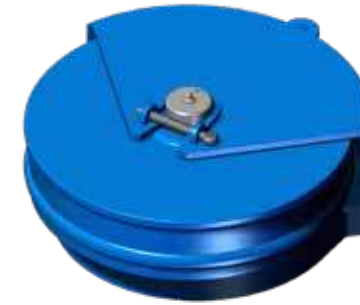

► **Corner Wheels:** Available in 90°, 180°, and Double-90°, Patz 12-inch corner wheels reduce system torque and maintain proper chain linkage through corners under load. Patz exclusive corner wheels are:

- True-round, cast-iron and through-hardened—not just the outside edge—to resist wear and pitting for longer service life.
- Designed to operate on a lubricated, solid steel axle with laminated sleeve bearing, anchored in the industry's most serviceable, in-laid housing.



► **Return Corner Guides:** Safely guide chain around inside corners utilizing a Patz guarded return corner or loaded reverse corner, which keeps chain on track and operators away from danger. Always ensure that return guards are installed before operating.

- Return Corner options available in 22°, 45°, and 90° for most standard Model 400 systems.
- Field cut concrete gutter return corners for custom angles 30° - 75°.

Genuine Patz Chain & Replacement Contact Points

SPECIFICATIONS

THE BEST **CHAIN WARRANTY** IN THE INDUSTRY!

- ✓ All Patz 400 Gutter Cleaner Chain is covered by a 15-year pro-rated (5-year full) coverage warranty.
- ✓ The Patz warranty reimburses the replacement cost of chain, not the original purchase price.
- ✓ A printed prorated schedule clearly states how reimbursement will be made – no guessing.
- ✓ Trust our reliable network of authorized Patz dealers to provide dependable service and excellent customer support.



Genuine Patz Chain	U/M	Recommend, maximum chain:
Circuit Length	ft (m)	400 (121.92)
Channel Depth	in (mm)	10 (254)
Spacing 12-inch		Chain is installed in a sequence of (1) link and (1) flite.
Spacing 18-inch		Chain is installed in a sequence of (2) links and (1) flite.
Spacing 24-inch		Chain is installed in a sequence of (3) links and (1) flite.
Capacity (at 36 FPM with 18-inch flite spacing, standard 18-inch width)		45 Cubic Feet (1.5yd ³) per minute, 41 Ton per hour (30lbs/FT ³)
All options may vary with select drive packages.		



CAUTION: Never operate Patz equipment without all shields and guards in place. *Safety Is No Accident.* Before operating any piece of equipment, be sure to read and understand the operator's manual. This manual should be kept with the machine at all times. Additionally, make sure all safety shields and devices are functioning properly and are securely in place.



For some photos in this brochure, guards were removed for photographic purposes only to allow viewing of the equipment features. Before operating equipment, all guards must be in place. Because Patz continually improves and updates products, Patz reserves the right to change the construction of machines or attachments or any part thereof without incurring any obligation to make like changes on Patz machines, or attachments previously delivered. Specifications and prices subject to change without notice.